



# Introduction to Embedded Systems

Sanjit A. Seshia

UC Berkeley  
EECS 149/249A  
Fall 2015

© 2008-2015: E. A. Lee, A. L. Sangiovanni-Vincentelli, S. A. Seshia. All rights reserved.

Chapter 7: Sensors and Actuators

What is a sensor? An actuator?

A sensor is a device that **measures** a physical quantity  
→ Input / “Read from physical world”

An actuator is a device that **modifies** a physical quantity  
→ Output / “Write to physical world”

## Sensors and Actuators – The Bridge between the Cyber and the Physical

### Sensors:

- Cameras
- Accelerometers
- Gyroscopes
- Strain gauges
- Microphones
- Magnetometers
- Radar/Lidar
- Chemical sensors
- Pressure sensors
- Switches
- ...

### Actuators:

- Motor controllers
- Solenoids
- LEDs, lasers
- LCD and plasma displays
- Loudspeakers
- Switches
- Valves
- ...

### Modeling Issues:

- Physical dynamics
- Noise
- Bias
- Sampling
- Interactions
- Faults
- ...

EECS 149/249A, UC Berkeley: 3

## Self-Driving Cars



Berkeley PATH Project Demo,  
1999, San Diego.

Google self-driving car 2.0



EECS 149/249A, UC Berkeley: 4

# Kingvale Blower Berkeley PATH Project, March, 2005



EECS 149/249A, UC Berkeley: 5

# Sensor-Rich Cars

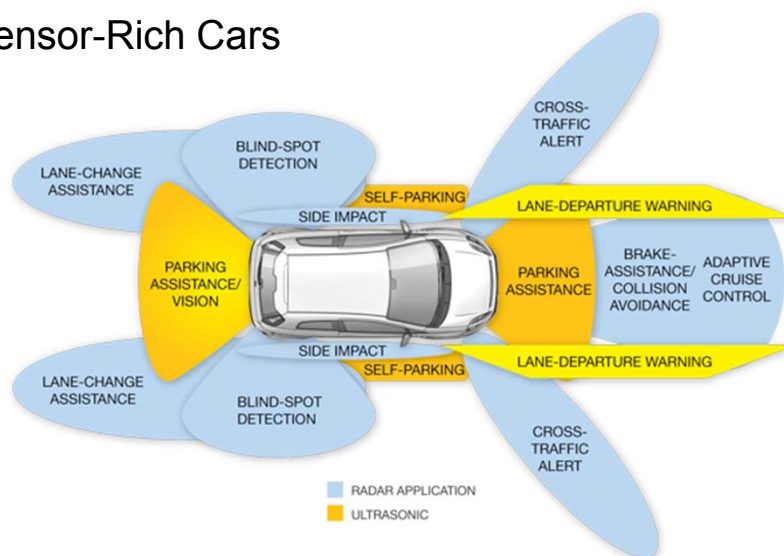

Source: Analog Devices

EECS 149/249A, UC Berkeley: 6

## Sensor-Rich Cars

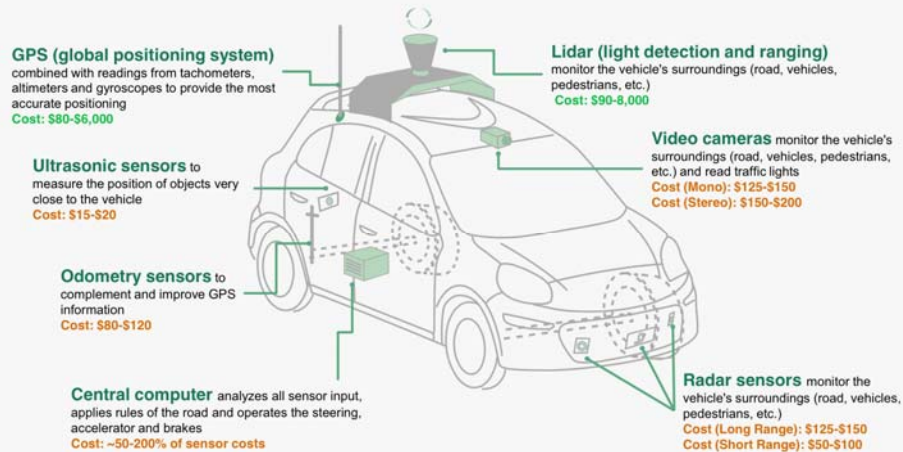

Source: Wired Magazine

EECS 149/249A, UC Berkeley: 7

## Kingvale Blower: Technology Overview Berkeley PATH Project, March, 2003



EECS 149/249A, UC Berkeley: 8

## Magnetometers

A very common type is the Hall Effect magnetometer.

Charge particles (electrons, 1) flow through a conductor (2) serving as a Hall sensor. Magnets (3) induce a magnetic field (4) that causes the charged particles to accumulate on one side of the Hall sensor, inducing a measurable voltage difference from top to bottom.

The four drawings at the right illustrate electron paths under different current and magnetic field polarities.

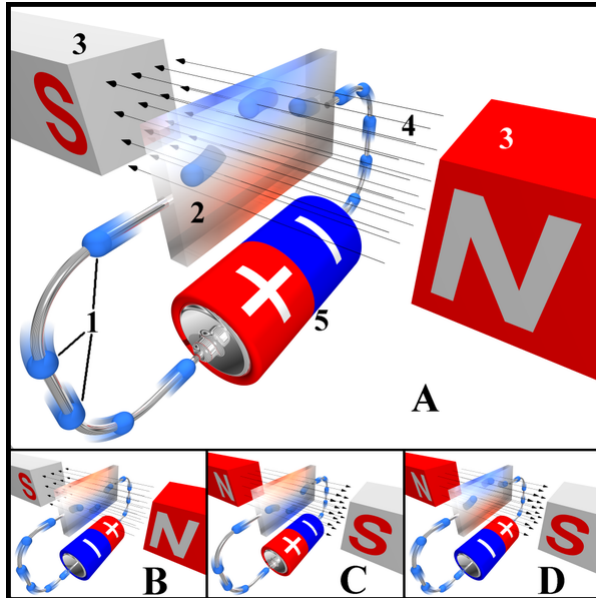

Image source: Wikipedia Commons

Edwin Hall discovered this effect in 1879.

EECS 149/249A, UC Berkeley: 9

## Roadmap for Lecture

- ❑ How Accelerometers work
- ❑ Affine Model of Sensors
- ❑ Bias and Sensitivity
- ❑ Faults in Sensors
- ❑ Brief Overview of Actuators

EECS 149/249A, UC Berkeley: 10

## Accelerometers

The most common design measures the distance between a plate fixed to the platform and one attached by a spring and damper. The measurement is typically done by measuring capacitance.

Uses:

- Navigation
- Orientation
- Drop detection
- Image stabilization
- Airbag systems

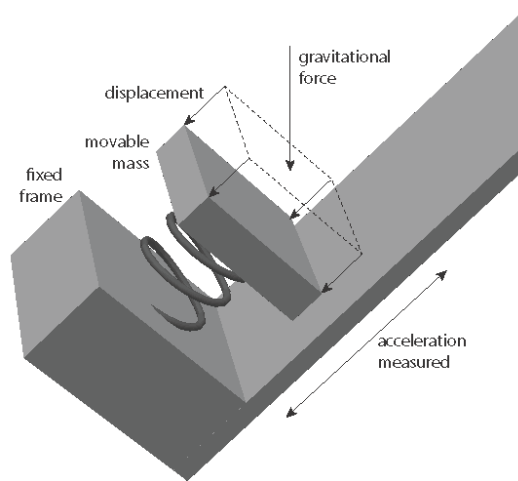

EECS 149/249A, UC Berkeley: 11

## Spring-Mass-Damper Accelerometer

By Newton's second law,  
 $F=ma$ .

For example,  $F$  could be the Earth's gravitational force.

The force is balanced by the restoring force of the spring.



EECS 149/249A, UC Berkeley: 12

## Spring-Mass-Damper System

- mass:  $M$
- spring constant:  $k$
- spring rest position:  $p$
- position of mass:  $x$
- viscous damping constant:  $c$

Force due to spring extension:

$$F_1(t) = k(p - x(t))$$

Force due to viscous damping:

$$F_2(t) = -c\dot{x}(t)$$

Newton's second law:

$$F_1(t) + F_2(t) = M\ddot{x}(t)$$

or

$$M\ddot{x}(t) + c\dot{x}(t) + kx(t) = kp.$$

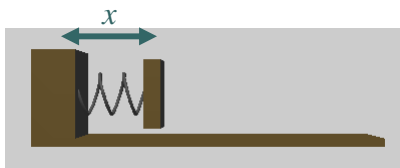

Exercise: Convert to an integral equation with initial conditions.

EECS 149/249A, UC Berkeley: 13

## Measuring tilt

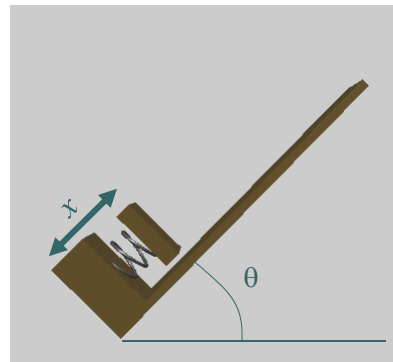

Component of gravitational force in the direction of the accelerometer axis must equal the spring force:

$$Mg \sin(\theta) = k(p - x(t))$$

Given a measurement of  $x$ , you can solve for  $\theta$ , up to an ambiguity of  $\pi$ .

EECS 149/249A, UC Berkeley: 14

## Difficulties Using Accelerometers

- Separating tilt from acceleration
- Vibration
- Nonlinearities in the spring or damper
- Integrating twice to get position: Drift

$$p(t) = p(0) + \int_0^t v(\tau) d\tau,$$

$$v(t) = v(0) + \int_0^t x(\tau) d\tau.$$

Position is the integral of velocity, which is the integral of acceleration. Bias in the measurement of acceleration causes position estimate error to increase quadratically.

EECS 149/249A, UC Berkeley: 15

## Inertial Navigation Systems

Dead reckoning plus GPS.

Combinations of:

- GPS (for initialization and periodic correction).
- Three axis gyroscope measures orientation.
- Three axis accelerometer, double integrated for position after correction for orientation.

Typical drift for systems used in aircraft have to be:

- 0.6 nautical miles per hour
- tenths of a degree per hour

Good enough? It depends on the application!

EECS 149/249A, UC Berkeley: 16



## Design Issues with Sensors

- Calibration
  - Relating measurements to the physical phenomenon
  - Can dramatically increase manufacturing costs
- Nonlinearity
  - Measurements may not be proportional to physical phenomenon
  - Correction may be required
  - Feedback can be used to keep operating point in the linear region
- Sampling
  - Aliasing
  - Missed events
- Noise
  - Analog signal conditioning
  - Digital filtering
  - Introduces latency

EECS 149/249A, UC Berkeley: 17

## Material to be covered on blackboard

Affine Sensor Model

Bias and Sensitivity

Example: Look at ADXL330 accelerometer datasheet

EECS 149/249A, UC Berkeley: 18

$x$  - Phy Qty  $x \in \mathbb{R}$

Sensor  $F: \mathbb{R} \rightarrow \mathbb{R}$

affine

$$F(x) = ax + b$$

$\uparrow$                        $\uparrow$   
sensitivity              bias

$$\frac{dF(x)}{dx} = a = \text{sensitivity}$$

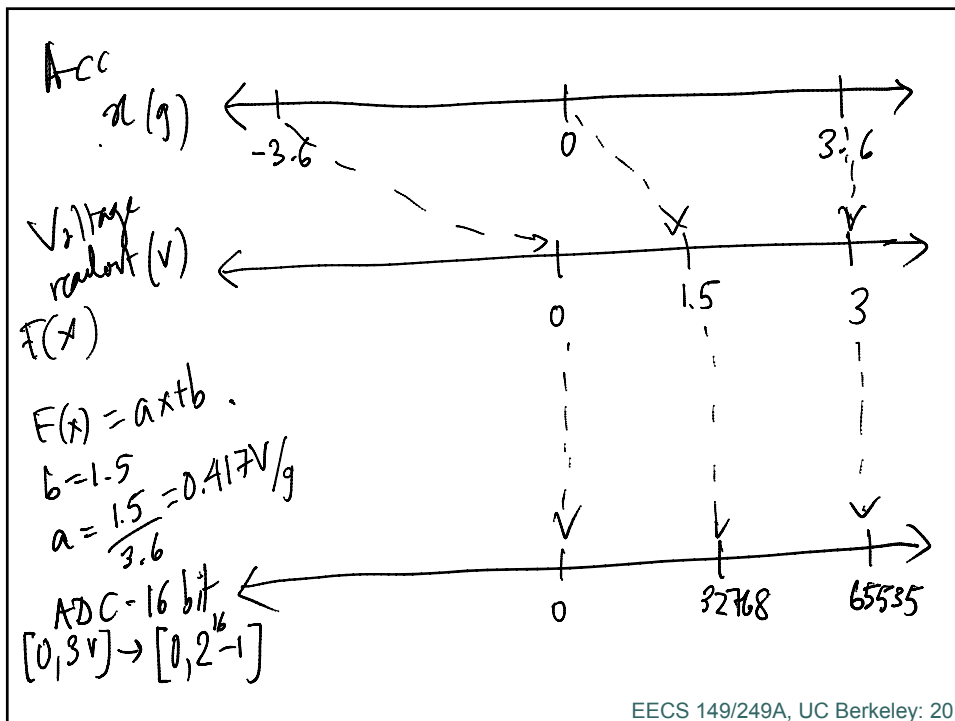

## Faults in Sensors

Sensors are physical devices

Like all physical devices, they suffer wear and tear, and can have manufacturing defects

Cannot assume that *all* sensors on a system will work correctly at *all* times

Solution: Use redundancy

→ However, must be careful *how* you use it!

EECS 149/249A, UC Berkeley: 21

## Violent Pitching of Qantas Flight 72 (VH-QPA)

An Airbus A330 en-route from Singapore to Perth on 7 October 2008

- Started pitching violently, unrestrained passengers hit the ceiling, 12 serious injuries, so counts as an accident
- Three Angle Of Attack (AOA) sensors, one on left (#1), two on right (#2, #3) of airplane nose
- Want to get a consensus good value
- Have to deal with inaccuracies, different positions, gusts/spikes, failures

[J. Rushby]

EECS 149/249A, UC Berkeley: 22

## A330 AOA Sensor Processing

- ❑ Sampled at 20Hz
- ❑ Compare each sensor to the median of the three
- ❑ If difference is larger than some threshold for more than 1 second, flag as faulty and ignore for remainder of flight
- ❑ Assuming all three are OK, use mean of #1 and #2 (because they are on different sides)
- ❑ If the difference between #1 or #2 and the median is larger than some (presumably smaller) threshold, use previous *average* value for 1.2 seconds
- ❑ Failure scenario: two spikes in #1, first shorter than 1 second, second still present 1.2 seconds after detection of first
- ❑ Result: flight control computers commanding a nose-down aircraft movement, which resulted in the aircraft pitching down to a maximum of about 8.5 degrees

[J. Rushby]

EECS 149/249A, UC Berkeley: 23

## How to deal with Sensor Errors

Difficult Problem, still research to be done

Possible approach: Intelligent sensor communicates an **interval**, not a point value

- Width of interval indicates confidence, health of sensor

[J. Rushby]

EECS 149/249A, UC Berkeley: 24

## Sensor Fusion: Marzullo's Algorithm

- ❑ **Axiom:** if sensor is nonfaulty, its interval contains the true value
- ❑ **Observation:** true value must be in overlap of nonfaulty intervals
- ❑ **Consensus (fused) Interval** to tolerate  $f$  faults in  $n$ :  
Choose interval that contains all overlaps of  $n - f$ ; i.e., from least value contained in  $n - f$  intervals to largest value contained in  $n - f$
- ❑ **Eliminating faulty samples:** separate problem, not needed for fusing, but any sample disjoint from the fused interval must be faulty

[J. Rushby]

EECS 149/249A, UC Berkeley: 25

## Example: 4 Interval Sensor Readings

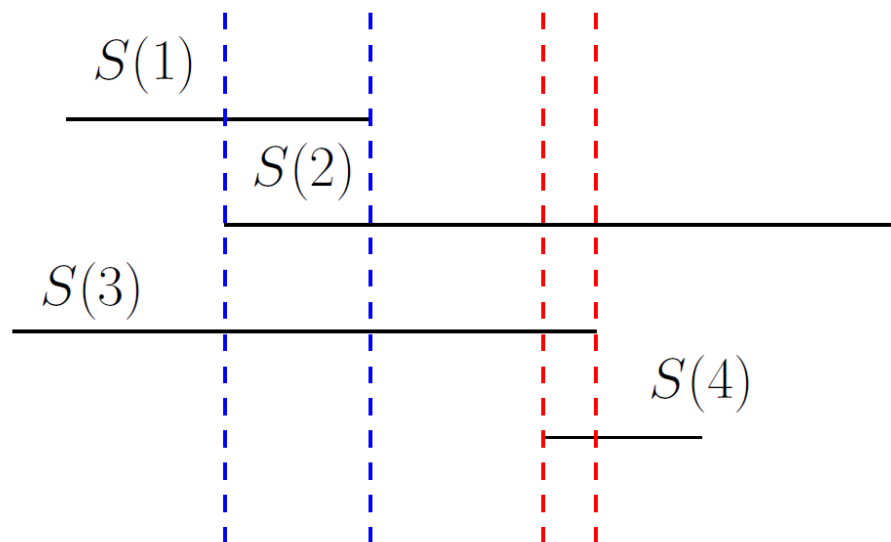

[J. Rushby]

EECS 149/249A, UC Berkeley: 26

### Example: Marzullo's Fusion Interval

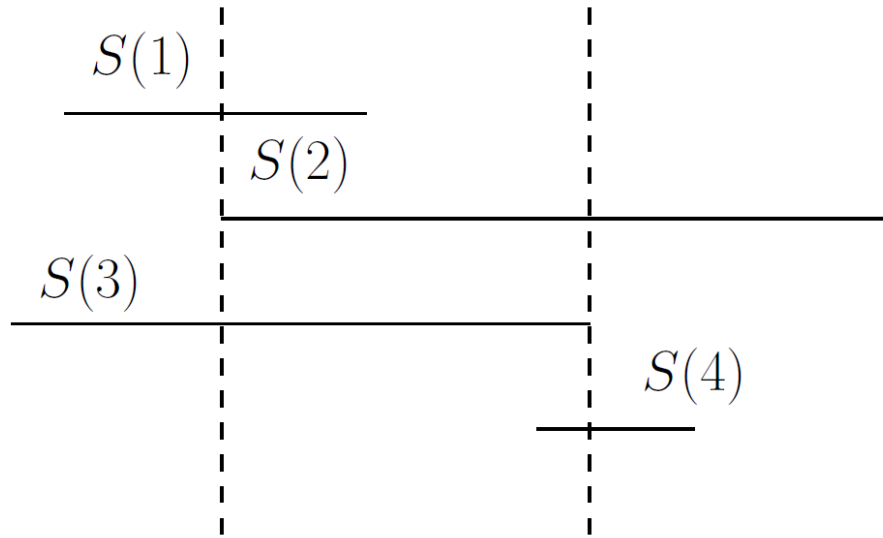

[J. Rushby]

EECS 149/249A, UC Berkeley: 27

### Example: Marzullo's Approach does not satisfy Lipshitz Condition

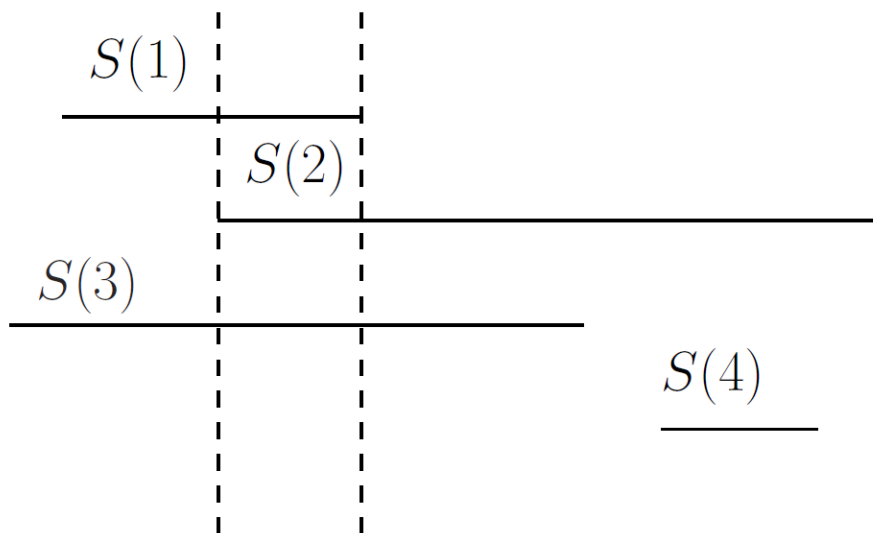

[J. Rushby]

EECS 149/249A, UC Berkeley: 28

## Schmid's Fusion Method

- ❑ Recall:  $n$  sensors, at most  $f$  faulty
- ❑ Choose interval from  $f+1^{\text{st}}$  largest lower bound to  $f+1^{\text{st}}$  smallest upper bound
- ❑ Optimal among selections that satisfy Lipschitz Condition

[J. Rushby]

EECS 149/249A, UC Berkeley: 29

## Example: Schmid's Interval satisfies Lipschitz Condition

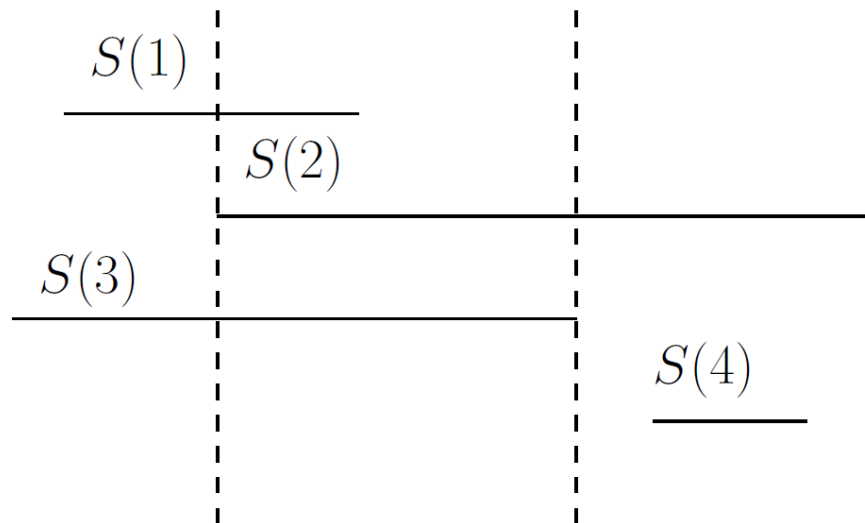

[J. Rushby]

EECS 149/249A, UC Berkeley: 30

## Motor Controllers

Bionic hand from Touch Bionics costs \$18,500, has and five DC motors, can grab a paper cup without crushing it, and turn a key in a lock. It is controlled by nerve impulses of the user's arm, combined with autonomous control to adapt to the shape of whatever it is grasping. Source: IEEE Spectrum, Oct. 2007.

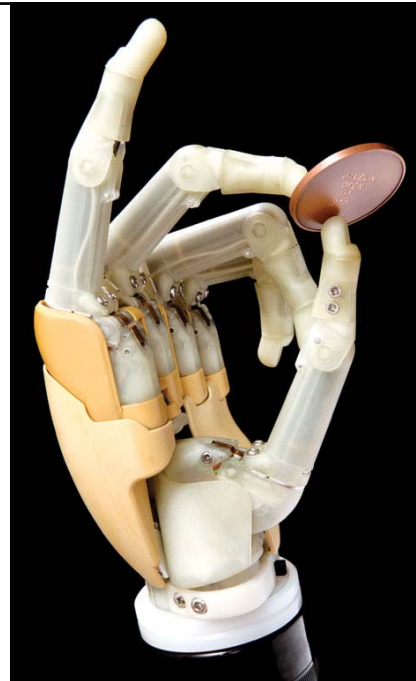

EECS 149/249A, UC Berkeley: 31

## Pulse-Width Modulation (PWM)

Delivering power to actuators can be challenging. If the device tolerates rapid on-off controls (“bang-bang” control), then delivering power becomes much easier.

Duty cycle around 10%

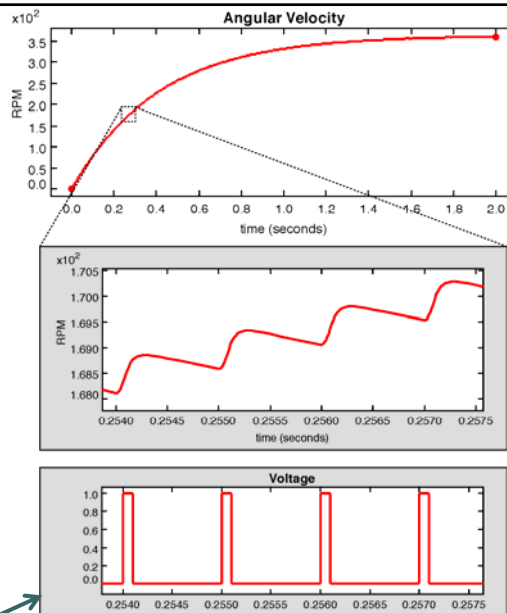

EECS 149/249A, UC Berkeley: 32



## Model of a Motor

Electrical Model:

$$v(t) = Ri(t) + L \frac{di(t)}{dt} + k_b \omega(t)$$

Back electromagnetic force constant

Angular velocity

Mechanical Model (angular version of Newton's second law):

$$I \frac{d\omega(t)}{dt} = k_T i(t) - \eta \omega(t) - \tau(t)$$

Moment of inertia

Torque constant

Friction

Load torque

EECS 149/249A, UC Berkeley: 33

## Summary for Lecture

- ❑ Overview of Sensors and Actuators
- ❑ How Accelerometers work
- ❑ Affine Model of Sensors
- ❑ Bias and Sensitivity
- ❑ Faults in Sensors
- ❑ Brief Overview of Actuators

EECS 149/249A, UC Berkeley: 34

Extra Slides Follow

EECS 149/249A, UC Berkeley: 35

Feedback dramatically improves accuracy and dynamic range of microaccelerometers.

The Berkeley Sensor and Actuator Center (BSAC) created the first silicon microaccelerometers, MEMS devices now used in airbag systems, computer games, disk drives (drop sensors), etc.

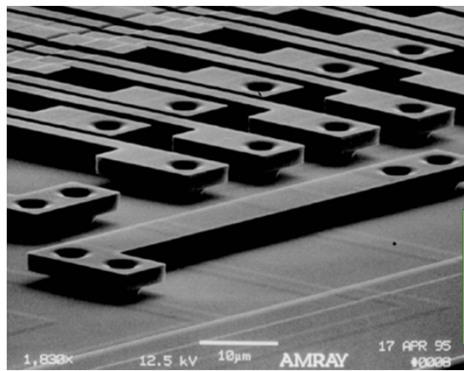
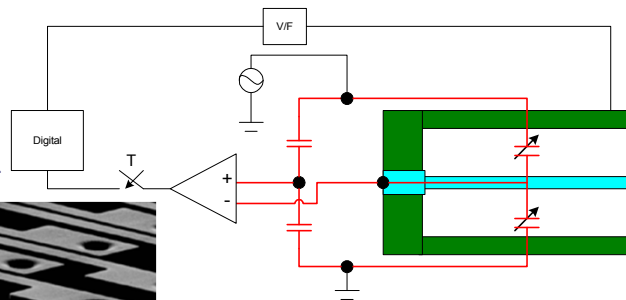

M. A. Lemkin, "Micro Accelerometer Design with Digital Feedback Control", Ph.D. dissertation, EECS, University of California, Berkeley, Fall 1997

EECS 149/249A, UC Berkeley: 36

## Measuring Changes in Orientation: Gyroscopes

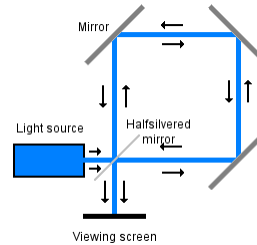

Optical gyros: Leverage the Sagnac effect, where a laser light is sent around a loop in opposite directions and the interference is measured. When the loop is rotating, the distance the light travels in one direction is smaller than the distance in the other. This shows up as a change in the interference.

Images from the Wikipedia Commons

EECS 149/249A, UC Berkeley: 37

## Strain Gauges



Mechanical strain gauge used to measure the growth of a crack in a masonry foundation. This one is installed on the Hudson-Athens Lighthouse. Photo by Roy Smith, used with permission.

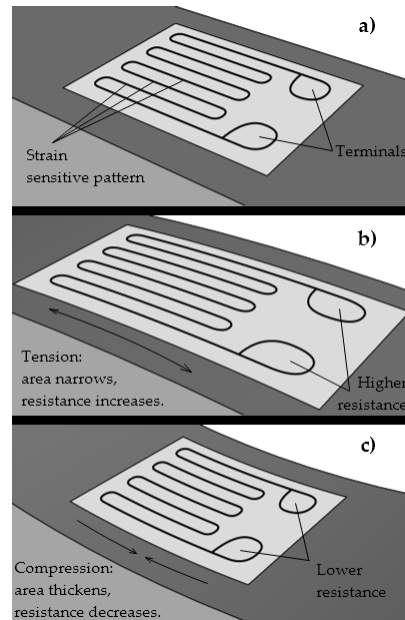

Images from the Wikipedia Commons

EECS 149/249A, UC Berkeley: 38

## Aliasing

Sampled data is vulnerable to *aliasing*, where high frequency components masquerade as low frequency components.

Careful modeling of the signal sources and analog signal conditioning or digital oversampling are necessary to counter the effect.

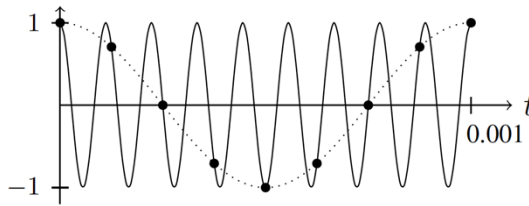

A high frequency sinusoid sampled at a low rate looks just like a low frequency sinusoid.

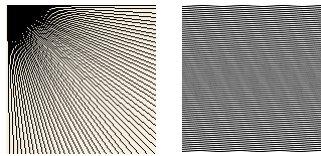

Digitally sampled images are vulnerable to aliasing as well, where patterns and edges appear as a side effect of the sampling. Optical blurring of the image prior to sampling avoids aliasing, since blurring is spatial low-pass filtering.

EECS 149/249A, UC Berkeley: 39

## Noise & Signal Conditioning

Parseval's theorem relates the energy or the power in a signal in the time and frequency domains. For a finite energy signal  $x$ , the energy is

$$\int_{-\infty}^{\infty} (x(t))^2 dt = \frac{1}{2\pi} \int_{-\infty}^{\infty} |X(\omega)|^2 d\omega$$

where  $X$  is the Fourier transform. If there is a desired part  $x_d$  and an undesired part (noise)  $x_n$ ,

$$x(t) = x_d(t) + x_n(t)$$

then

$$X(\omega) = X_d(\omega) + X_n(\omega)$$

Suppose that  $x_d$  is a narrowband signal and  $x_n$  is a broadband signal. Then the *signal to noise ratio* (SNR) can be greatly improved with filtering.

*Example:*

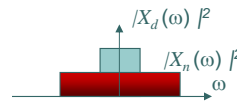

*Filter:*

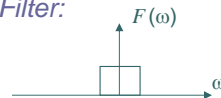

*Filtered signal:*

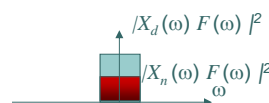

*A full treatment of this requires random processes.*

EECS 149/249A, UC Berkeley: 40